

N-Channel Enhancement Mode Field Effect Transistor

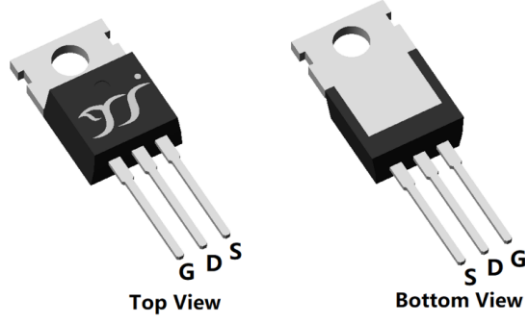

TO-220

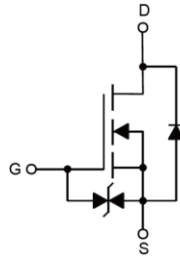

Product Summary

- V_{DS} 800V
- I_D 19A
- $R_{DS(ON)}$ (at $V_{GS}=10V$) <240m Ω
- 100% EAS Tested
- 100% ∇V_{DS} Tested

General Description

- Excellent package for heat dissipation
- High density cell design for low $R_{DS(ON)}$
- Epoxy Meets UL 94 V-0 Flammability Rating
- Halogen Free

Applications

- Power switching application
- Uninterruptible power supply
- DC-DC converter

Limiting Values

Parameter	Conditions	Symbol	Min	Max	Unit	
Drain-source Voltage		V_{DS}	-	800	V	
Gate-source Voltage		V_{GS}	-30	30		
Continuous Drain Current (Note 1,2)	Steady-State	I_D	$T_A=25^\circ\text{C}, V_{GS}=10V$	-	2.4	A
			$T_A=100^\circ\text{C}, V_{GS}=10V$	-	1.5	
Continuous Drain Current (Note 1,3)	Steady-State	I_D	$T_C=25^\circ\text{C}, V_{GS}=10V, \text{Chip limitation}$	-	19	
			$T_C=100^\circ\text{C}, V_{GS}=10V$	-	12	
Pulsed Drain Current	$T_C=25^\circ\text{C}, t_p \leq 10\mu\text{s}$	I_{DM}	-	45		
Maximum Body-Diode Continuous Current	$T_C=25^\circ\text{C}$	I_S	-	19		
Maximum Body-Diode Pulsed Current	$T_C=25^\circ\text{C}, t_p \leq 10\mu\text{s}$	I_{SM}	-	45		
Avalanche energy (non-repetitive)	$T_J=25^\circ\text{C}, V_G=10V, R_G=25\Omega, L=20\text{mH}, I_{AS}=4.5A$	EAS	-	202.5	mJ	
Total Power Dissipation (Note 1,2)	Steady-State	P_D	$T_A=25^\circ\text{C}$	-	3.9	W
			$T_A=100^\circ\text{C}$	-	1.5	
Total Power Dissipation (Note 1,3)	Steady-State	P_D	$T_C=25^\circ\text{C}$	-	240	
			$T_C=100^\circ\text{C}$	-	96	
MOSFET dv/dt ruggedness	$V_{DS}=0 \dots 400V, R_g=0\Omega$	dv/dt	-	47.6	V/ns	
Reverse diode dv/dt	$V_{DS}=0 \dots 400V, I_D \leq 15A, di/dt=200A/\mu\text{s}$	dv/dt	-	16.6		
Maximum diode commutation speed	$V_{DS}=0 \dots 400V, I_D \leq 15A, R_g=0\Omega$	dif/dt	-	7660	A/ μs	
Junction and Storage Temperature Range		T_J, T_{STG}	-55	150	$^\circ\text{C}$	

Thermal resistance

Parameter	Symbol	Typ	Max	Units
Thermal Resistance Junction-to-Ambient (Note 2)	$R_{\theta JA}$	-	32	$^\circ\text{C/W}$
Thermal Resistance Junction-to-Case	$R_{\theta JC}$	-	0.52	

Ordering Information (Example)

PREFERRED P/N	PACKING CODE	Marking	MINIMUM PACKAGE(pcs)	INNER BOX QUANTITY(pcs)	OUTER CARTON QUANTITY(pcs)	DELIVERY MODE
YJP210C80BHJ	B1	YJP210C80B	50	/	5000	Tube



YJP210C80BHJ

■ Electrical Characteristics

Parameter	Symbol	Conditions	Min	Typ	Max	Units
Static Parameter						
Drain-Source Breakdown Voltage	BV_{DSS}	$V_{GS}=0V, I_D=250\mu A, T_j=25^\circ C$	800	-	-	V
Zero Gate Voltage Drain Current	I_{DSS}	$V_{DS}=800V, V_{GS}=0V, T_j=25^\circ C$	-	-	1	μA
		$V_{DS}=800V, V_{GS}=0V, T_j=150^\circ C$	-	-	100	
Gate-Source Leakage Current	I_{GSS}	$V_{GS}=\pm 30V, V_{DS}=0V, T_j=25^\circ C$	-	-	± 10	μA
Gate Threshold Voltage	$V_{GS(th)}$	$V_{DS}=V_{GS}, I_D=250\mu A, T_j=25^\circ C$	2.2	3	3.8	V
Static Drain-Source On-Resistance	$R_{DS(on)}$	$V_{GS}=10V, I_D=8.5A, T_j=25^\circ C$	-	200	240	m Ω
		$V_{GS}=10V, I_D=8.5A, T_j=150^\circ C$	-	541	650	
Diode Forward Voltage	V_{SD}	$I_S=19A, V_{GS}=0V, T_j=25^\circ C$	-	0.87	1.2	V
Gate resistance	R_G	$f=1MHz, T_j=25^\circ C$	-	2.9	-	Ω
Dynamic Parameters						
Input Capacitance	C_{iss}	$V_{DS}=400V, V_{GS}=0V, f=1MHz, T_j=25^\circ C$	-	2200	-	pF
Output Capacitance	C_{oss}		-	43	-	
Reverse Transfer Capacitance	C_{rss}		-	1.9	-	
Effective output capacitance, energy related	$C_{o(er)}$	$V_{DS}=0\dots 400V, V_{GS}=0V, f=1MHz, T_j=25^\circ C$	-	2200	-	
Effective output capacitance, time related	$C_{o(tr)}$		-	2210	-	
Switching Parameters						
Total Gate Charge	Q_g	$V_{GS}=10V, V_{DS}=400V, I_D=16A, T_j=25^\circ C$	-	48.6	-	nC
Gate-Source Charge	Q_{gs}		-	10	-	
Gate-Drain Charge	Q_{gd}		-	17.5	-	
Reverse Recovery Charge	Q_{rr}	$I_F=16A, di/dt=100A/\mu s, V_{GS}=0V, V_R=400V, T_j=25^\circ C$	-	5713	-	nC
Reverse Recovery Time	t_{rr}		-	340	-	ns
Peak Reverse Recovery Current	I_{rrm}		-	28.5	-	A
Turn-on Delay Time	$t_{D(on)}$	$V_{GS}=10V, V_{DS}=400V, I_D=16A, R_{GEN}=3\Omega, T_j=25^\circ C$	-	38.6	-	ns
Turn-on Rise Time	t_r		-	20.6	-	
Turn-off Delay Time	$t_{D(off)}$		-	43.3	-	
Turn-off fall Time	t_f		-	13.2	-	

Note:

- The entire application environment impacts the thermal resistance values shown, they are not constants and are only valid for the particular conditions noted.
- The value of $R_{\theta JA}$ is measured with the device mounted on the 40mm*40mm*1.1mm single layer FR-4 PCB board with 1 in² pad of 2oz. Copper, in the still air environment with $T_A=25^\circ C$. The maximum allowed junction temperature of $150^\circ C$. The value in any given application depends on the user's specific board design.
- Thermal resistance from junction to soldering point (on the exposed drain pad)



YJP210C80BHJ

Typical Electrical and Thermal Characteristics Diagrams

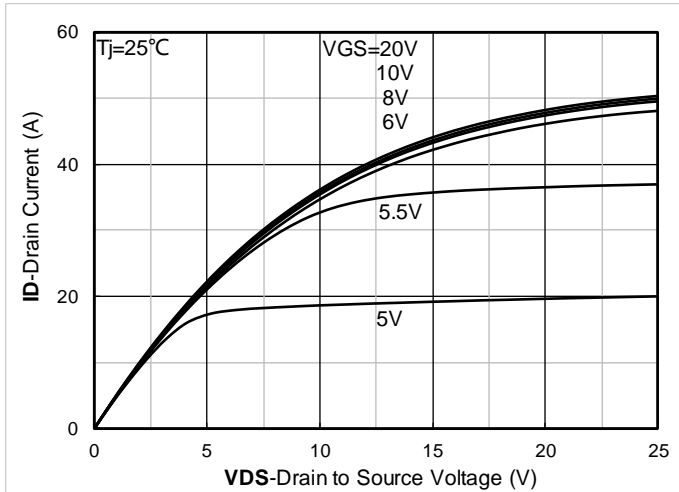

Figure 1. Output Characteristics; typical values

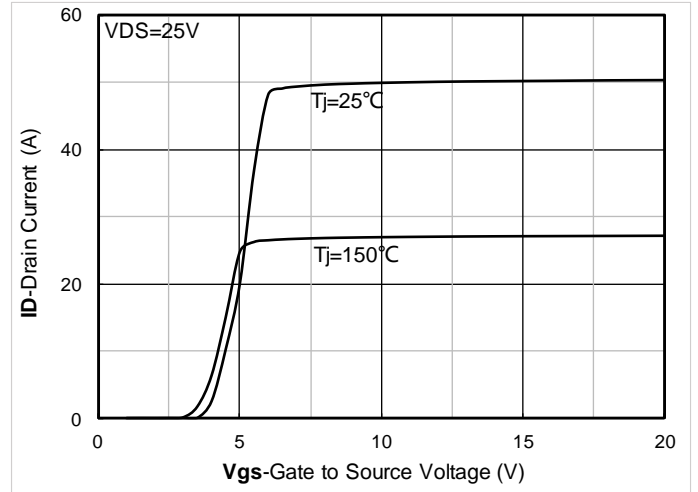

Figure 2. Transfer Characteristics; typical values

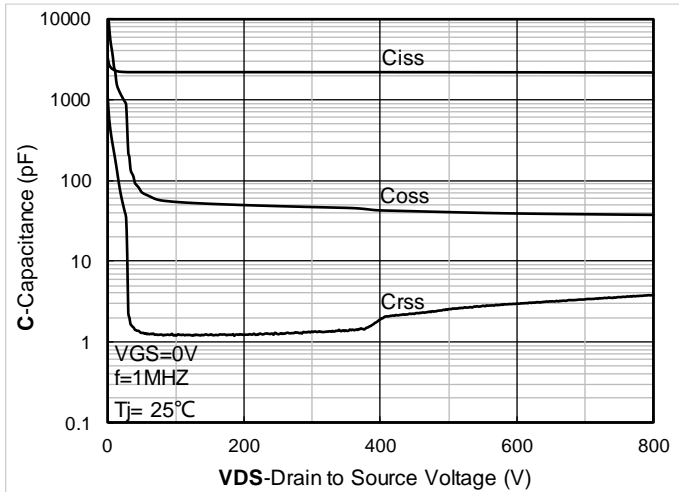

Figure 3. Capacitance Characteristics; typical values

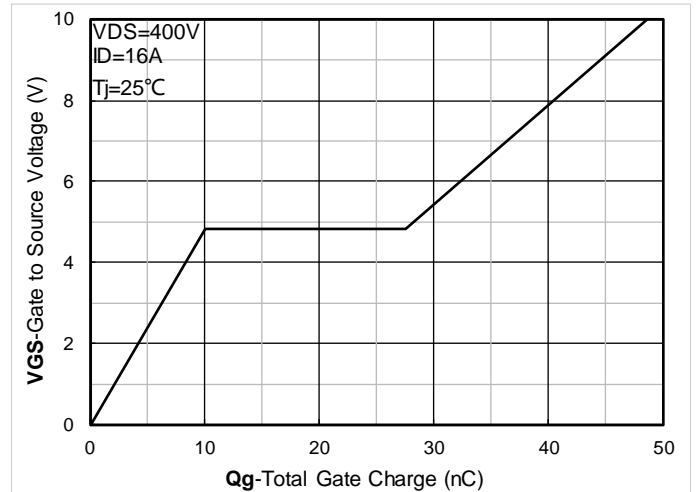

Figure 4. Gate Charge; typical values

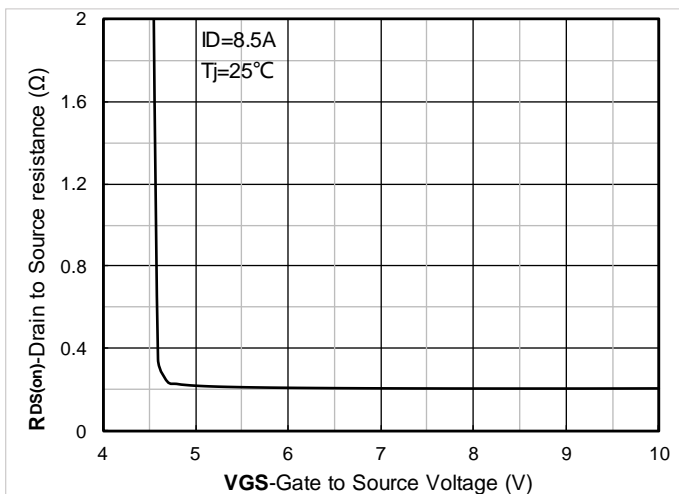

Figure 5. On-Resistance vs Gate to Source Voltage; typical values

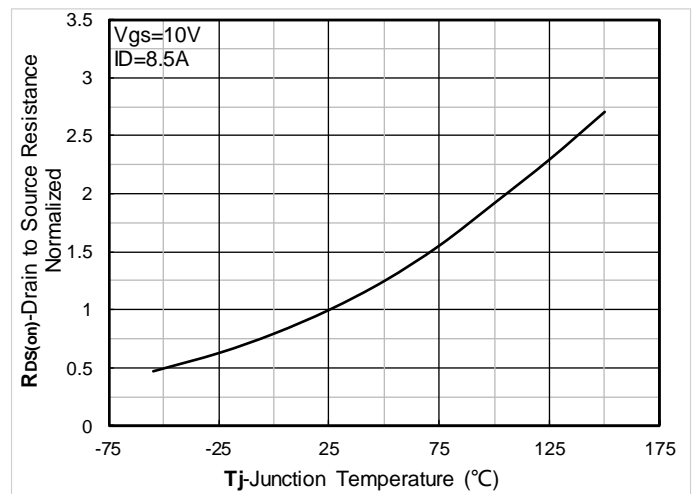

Figure 6. Normalized On-Resistance



YJP210C80BHJ

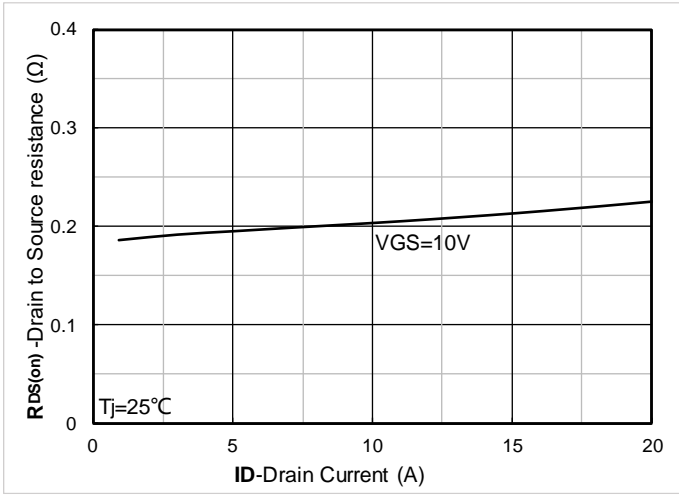

Figure 7. RDS(on) VS Drain Current; typical values

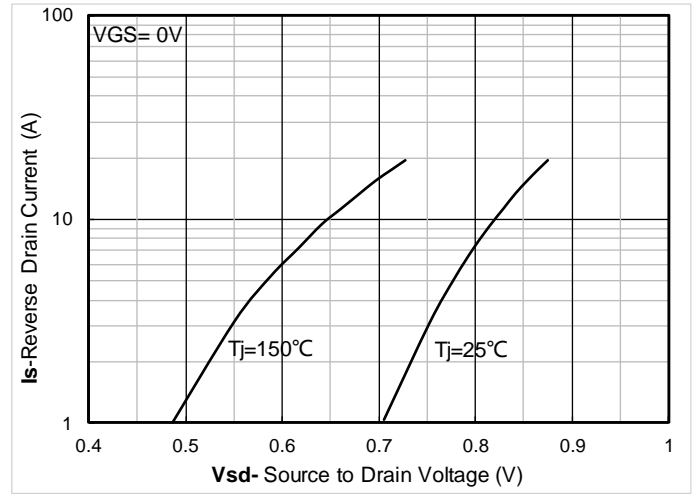

Figure 8. Forward characteristics of reverse diode; typical values

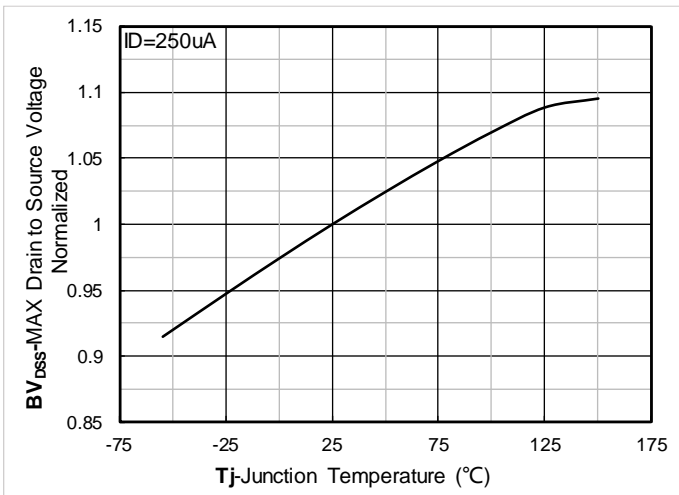

Figure 9. Normalized breakdown voltage

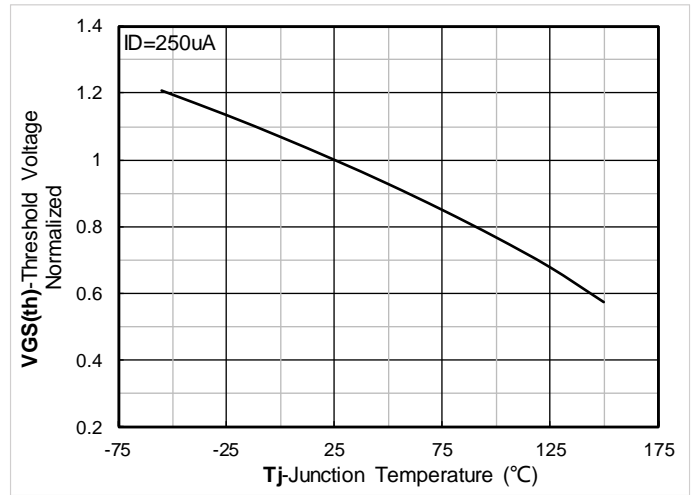

Figure 10. Normalized Threshold voltage

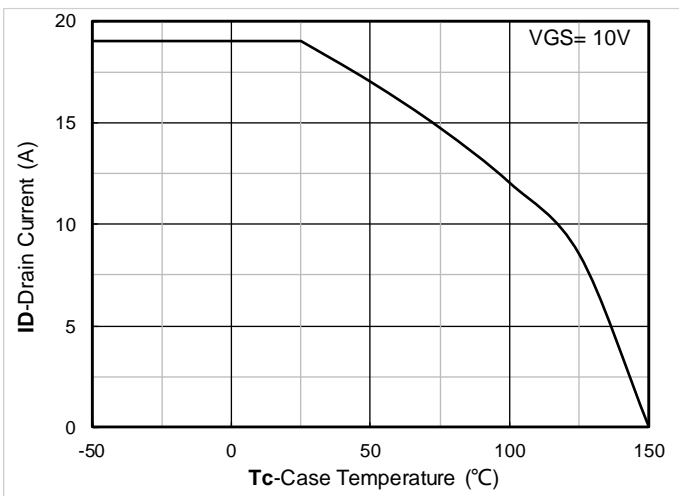

Figure 11. Current dissipation

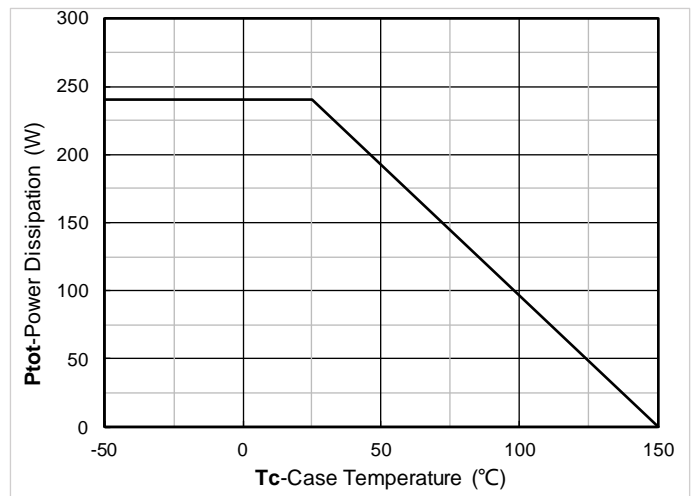

Figure 12. Power dissipation



YJP210C80BHJ

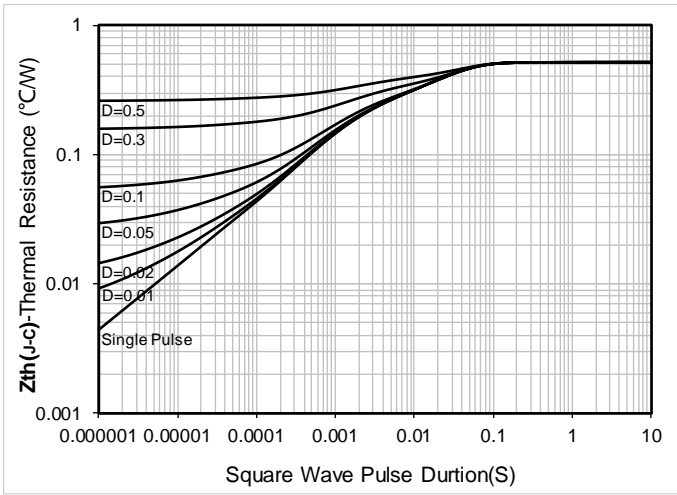

Figure 13. Maximum Transient Thermal Impedance

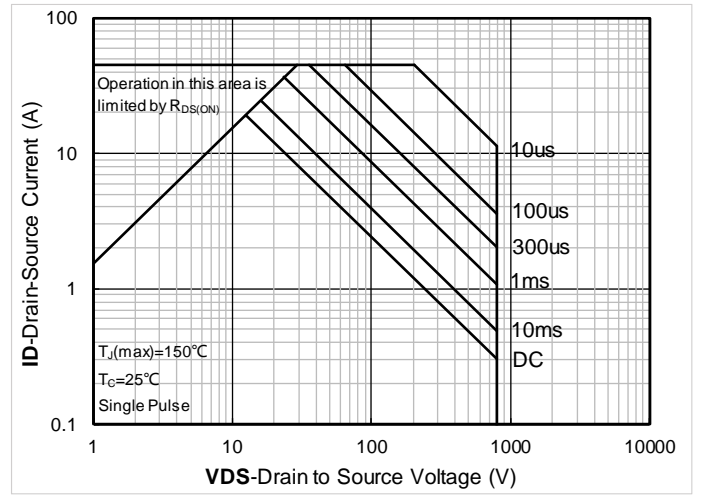
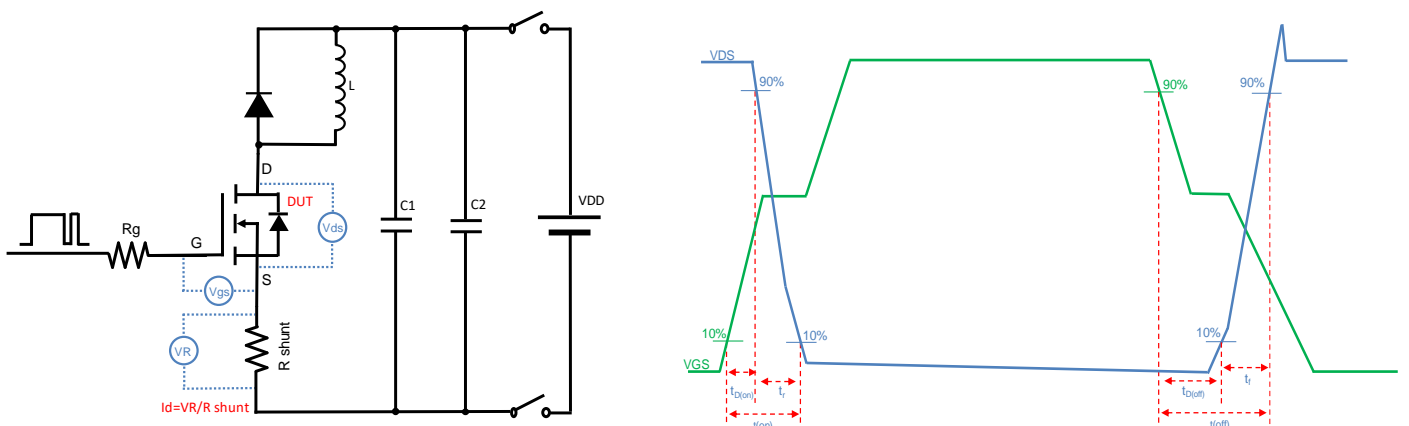
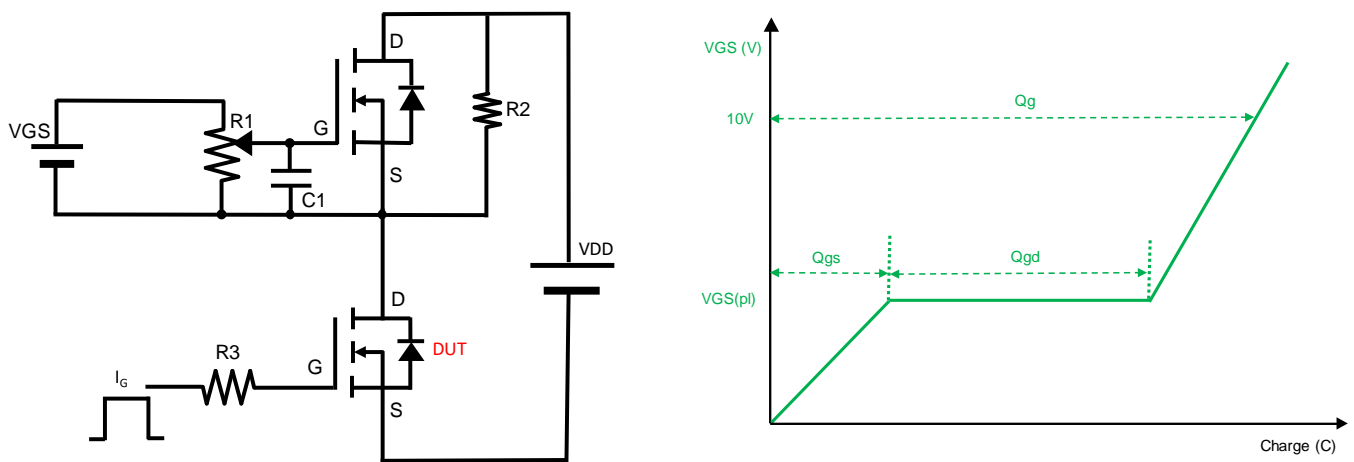
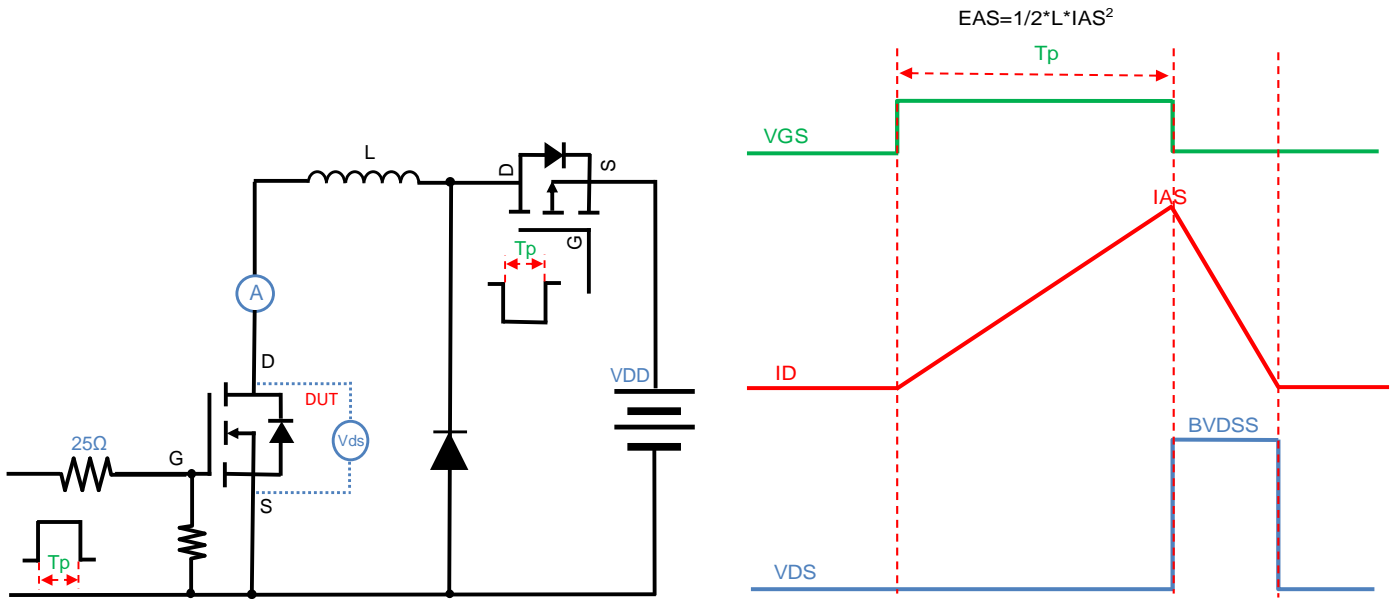

Figure 14. Safe Operation Area

■ Test Circuits & Waveforms



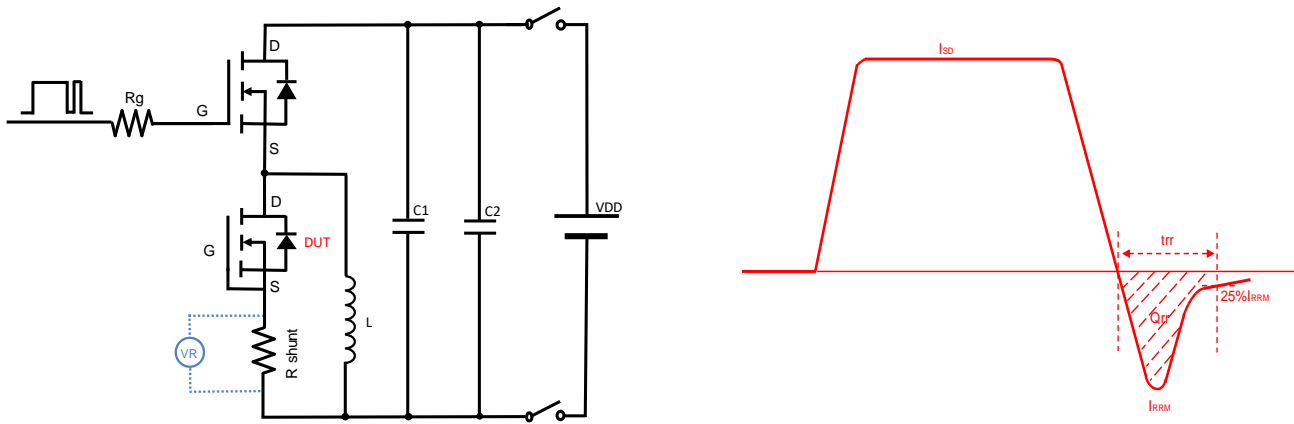
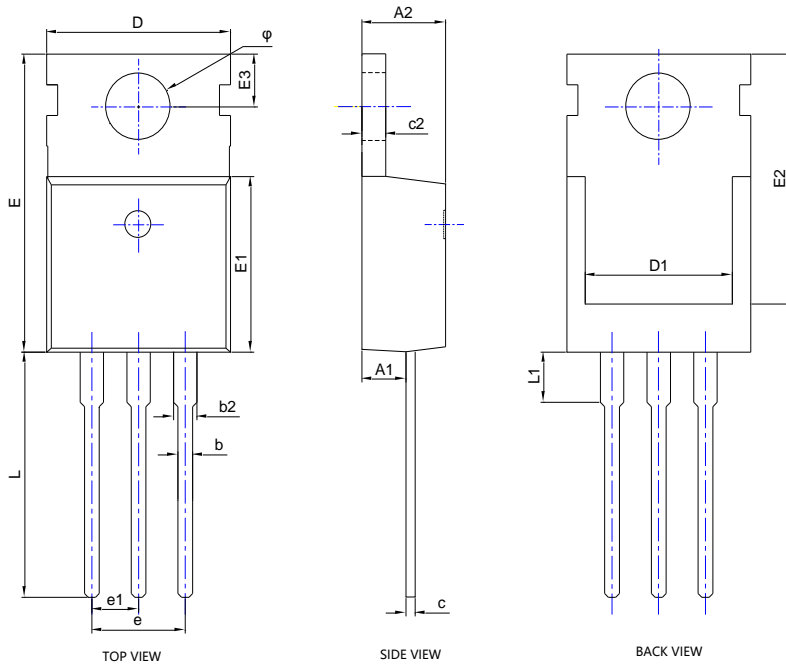

Figure D. Diode Recovery Test Circuit & Waveform



YJP210C80BHJ

■ TO-220AB-E Package information



SYMBOL	DIMENSIONS			
	INCHES		Millimeter	
	MIN.	MAX.	MIN.	MAX.
A1	0.093	0.114	2.350	2.900
A2	0.176	0.184	4.470	4.670
b	0.028	0.036	0.710	0.910
b2	0.048	0.054	1.220	1.360
c	0.019	0.024	0.470	0.600
c2	0.047	0.055	1.200	1.400
D	0.382	0.408	9.700	10.370
D1	0.276	0.350	7.000	8.890
E	0.579	0.622	14.700	15.800
E1	0.350	0.373	8.900	9.470
E2	0.463	0.535	11.750	13.600
E3	0.108BSC		2.740BSC	
e	0.200BSC		5.080BSC	
e1	0.100BSC		2.540BSC	
L	0.508	0.583	12.900	14.800
L1	0.100	0.151	2.540	3.840
φ	0.142	0.154	3.600	3.900

NOTE:
 1. PACKAGE BODY SIZES EXCLUDE MOLD FLASH AND GATE BURRS.
 2. TOLERANCE 0.1mm UNLESS OTHERWISE SPECIFIED.



YJP210C80BHJ

Disclaimer

The information presented in this document is for reference only. Yangzhou Yangjie Electronic Technology Co., Ltd. reserves the right to make changes without notice for the specification of the products displayed herein to improve reliability, function or design or otherwise.

The product listed herein is designed to be used with ordinary electronic equipment or devices, and not designed to be used with equipment or devices which require high level of reliability and the malfunction of which would directly endanger human life (such as medical instruments, transportation equipment, aerospace machinery, nuclear-reactor controllers, fuel controllers and other safety devices), Yangjie or anyone on its behalf, assumes no responsibility or liability for any damages resulting from such improper use of sale.

This publication supersedes & replaces all information previously supplied. For additional information, please visit our website <http://www.21yangjie.com> , or consult your nearest Yangjie's sales office for further assistance.