

## 1200V SiC MOSFET Power Module



$V_{DS}$	1200V
$I_D$	53A
$R_{DS(on)}$	42m $\Omega$

### Applications

- Photovoltaic Inverter
- Battery Charger
- Server Power Supplies
- Energy Storage System

### Features

- Zero Turn-off Tail Current
- Normally-off N-channel MOSFET
- High Frequency Operation
- Low Switching Loss
- Low Inductance Screw Connectors
- Isolated Baseplate (SOT-227)

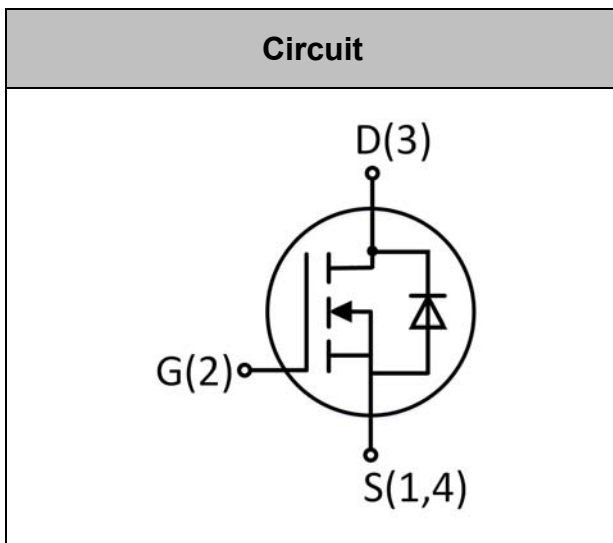

## ● MOSFET

Absolute Maximum Ratings (Per Position) ( $T_J=25^\circ\text{C}$  Unless Otherwise Specified)

Parameter	Symbol	Conditions	Value	Unit
Drain-Source Voltage	$V_{DS,max}$	$V_{GS}=0\text{ V}$ , $I_{DS}=100\mu\text{A}$	1200	V
Continuous Drain Current	$I_D$	$V_{GS}=20\text{V}$ , $T_C=25^\circ\text{C}$	53	A
		$V_{GS}=20\text{V}$ , $T_C=80^\circ\text{C}$	42	
Pulse Drain Current	$I_{D,pulse}$	Pulse width $t_p$ limited by $T_{J,max}$	223	A
Power Dissipation	$P_{D\_MOS}$	$T_C=25^\circ\text{C}$	223	W
Recommend Gate Source Voltage	$V_{GS,op}$	Static, recommended DC operating values	-5/20	V
Maximum Gate Source Voltage	$V_{GS,max}$	Absolute maximum values	-10/25	V
Max Junction Temperature	$T_{J,max}$		175	$^\circ\text{C}$



# MC40UZ12ST

RoHS  
COMPLIANT

## ● MOSFET

Characteristic Values (Per Position) ( $T_J=25^\circ\text{C}$  Unless Otherwise Specified)

Parameter	Symbol	Conditions	Value			Unit
			Min.	Typ.	Max.	
Drain-Source Breakdown Voltage	$V_{(BR)DSS}$	$V_{GS}=0V, I_D=100\mu A$	1200			V
Gate Threshold Voltage	$V_{GS(th)}$	$V_{DS}=V_{GS}, I_D=40mA$	1.5	2.6	4.0	V
		$V_{DS}=V_{GS}, I_D=40mA, T_J=175^\circ\text{C}$		1.8		
Zero Gate Voltage Drain Current	$I_{DSS}$	$V_{DS}=1200V, V_{GS}=0V$		1	50	$\mu A$
Gate-Source Leakage Current	$I_{GSS}$	$V_{DS}=0V, V_{GS}=20V$			250	nA
Drain-Source On-Resistance	$R_{DS(on)}$	$I_D=30A, V_{GS}=20V$		42	52	m $\Omega$
		$I_D=30A, V_{GS}=20V, T_J=175^\circ\text{C}$		77		
Transconductance	$g_{fs}$	$V_{DS}=20V, I_D=30A$		16		S
		$V_{DS}=20V, I_D=30A, T_J=175^\circ\text{C}$		14.5		
Internal Gate Resistance	$R_{G(int.)}$	$f=1MHz, V_{AC}=25mV$		0.9		$\Omega$
Input Capacitance	$C_{iss}$	$V_{GS}=0V,$ $V_{DS}=800V,$ $f=1MHz,$ $V_{AC}=25mV$		4460		pF
Output Capacitance	$C_{oss}$			201		
Reverse Transfer Capacitance	$C_{rss}$			32.3		
$C_{oss}$ Stored Energy	$E_{oss}$			67		
Gate to Source Charge	$Q_{GS}$	$V_{DD}=800V,$ $V_{GS}=-5/20V,$ $I_D=30A$		42		nC
Gate to Drain Charge	$Q_{GD}$			91		
Total Gate Charge	$Q_G$			233		
Turn On Delay Time	$t_{d(on)}$	$V_{DD}=800V, V_{GS}=-5/20V,$ $I_D=30A, R_{G(ext)}=2.7\Omega,$ $L=100\mu H$		30		ns
Rise Time	$t_r$			27		
Turn Off Delay Time	$t_{d(off)}$			40		
Fall Time	$t_f$			21		
Turn-on Switching Energy	$E_{on}$			920		$\mu J$
Turn-off Switching Energy	$E_{off}$			191		
MOSFET Thermal Resistance, Junction to Case	$R_{thJC}$	JESD51-14		0.65		$^\circ\text{C/W}$



## ● Body Diode

Characteristic Values (Per Position) ( $T_J=25^\circ\text{C}$  Unless Otherwise Specified)

Parameter	Symbol	Conditions	Value			Unit
			Min.	Typ.	Max.	
Inverse Diode Forward Voltage	$V_{SD}$	$V_{GS}=0V, I_F=7.5A$		2.9		V
		$V_{GS}=0V, I_F=7.5A, T_J=175^\circ\text{C}$		2.6		
Continuous Diode Forward Current	$I_S$	$V_{GS}=0V, T_C=25^\circ\text{C}$		48		A
Reverse Recovery Time	$t_{rr}$	$V_{GS}=0V,$ $I_S=30A, V_R=400V,$ $di/dt=300A/\mu s$		144		ns
Reverse Recovery Charge	$Q_{rr}$			176		nC
Peak Reverse Recovery Current	$I_{rrm}$			7		A

## ● Module Characteristics

Parameter	Symbol	Conditions	Value	Unit
Isolation Breakdown Voltage	$V_{isol}$	AC, 50Hz (R.M.S), $t=3s$	3600	V
Operating Temperature	$T_{Jop}$		-55~175	$^\circ\text{C}$
Storage Temperature	$T_{stg}$		-55~175	$^\circ\text{C}$
Mounting Torque	M	Recommended (M4 screw)	1~1.5	Nm
Terminal Connection Torque		Recommended (M4 screw)	1~1.5	
Weight	W		29	g

## ● Typical Performance

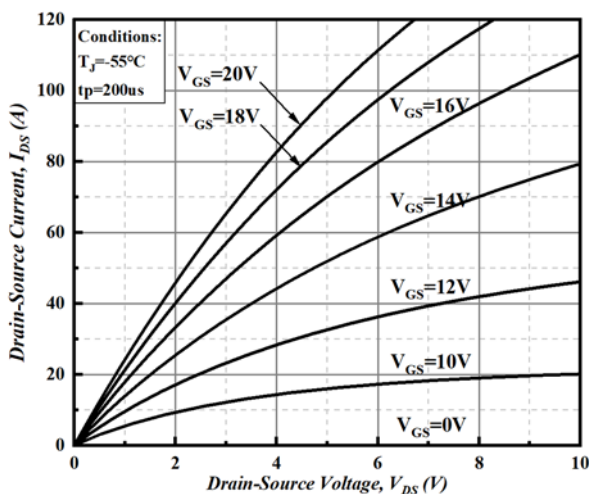

Figure 1. Output Characteristics  $T_J = -55^\circ\text{C}$

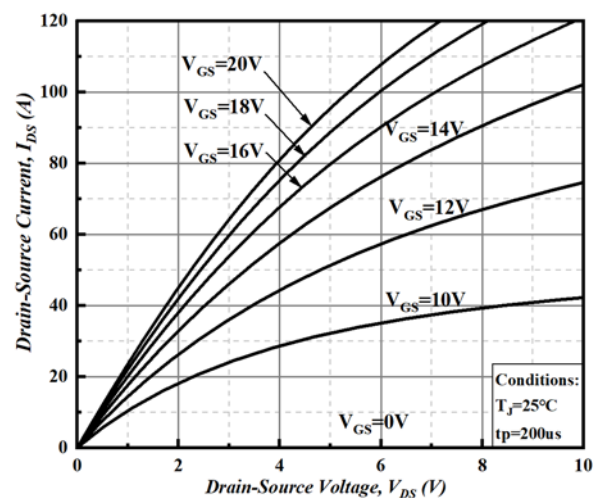

Figure 2. Output Characteristics  $T_J = 25^\circ\text{C}$

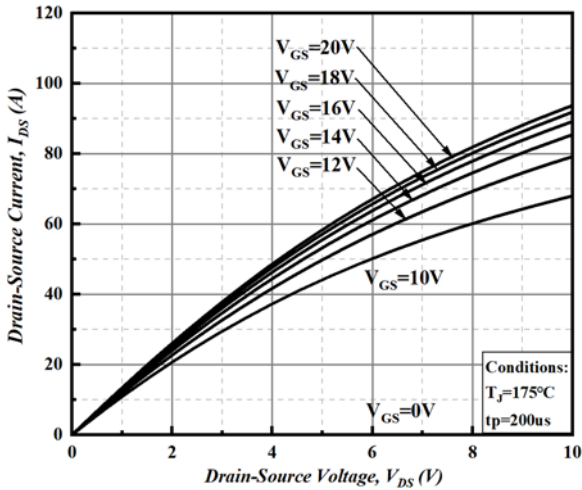

Figure 3. Output Characteristics  $T_J = 175^\circ\text{C}$

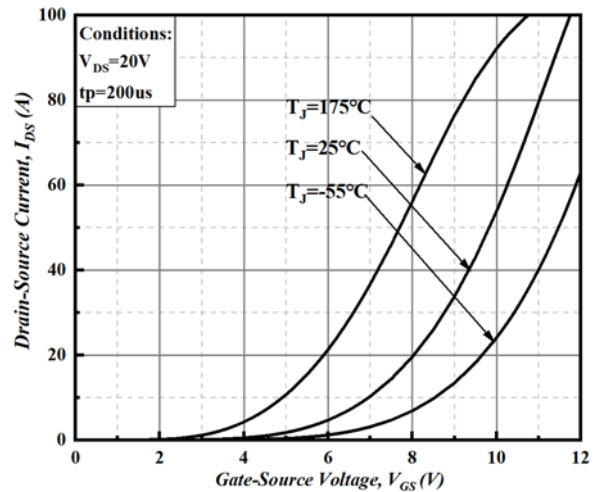

Figure 4. Transfer Characteristic for Various Junction Temperatures

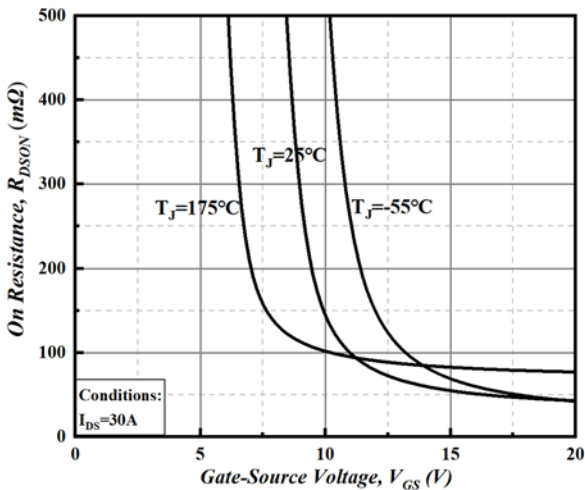

Figure 5. On-Resistance vs Gate Voltage For Various Junction Temperatures

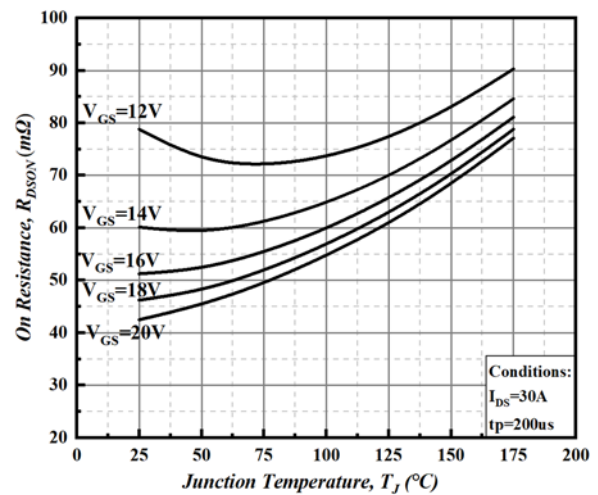

Figure 6. On-Resistance vs Temperature For Various Gate Voltage

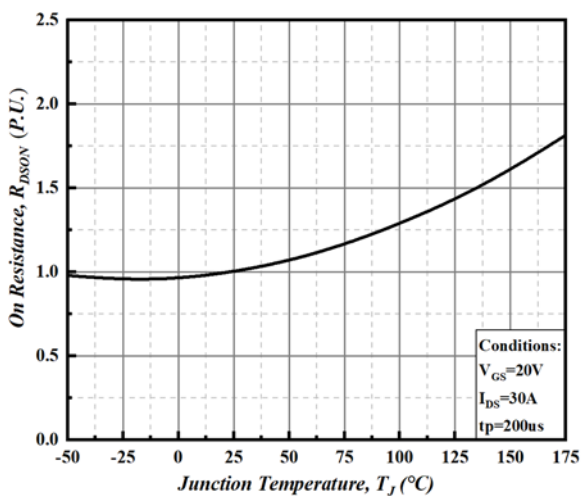

Figure 7. Normalized On-Resistance vs Temperature

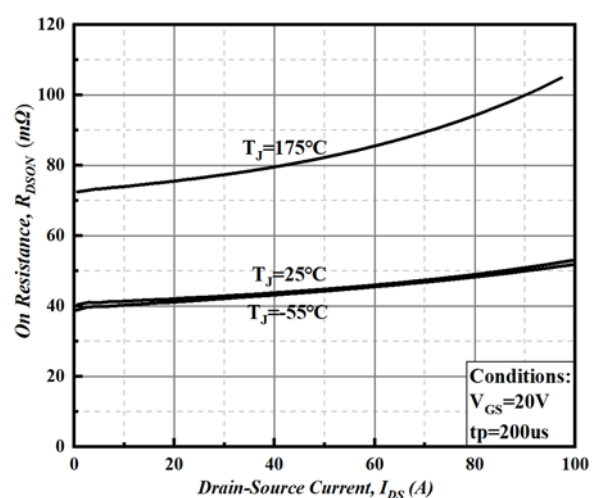

Figure 8. On-Resistance vs Drain Current



# MC40UZ12ST

RoHS  
COMPLIANT

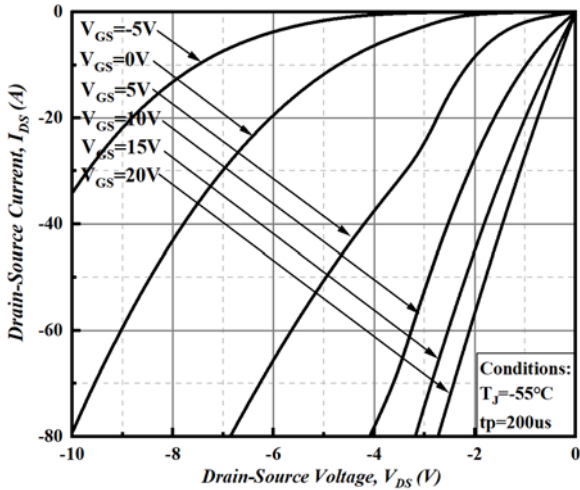

Figure 9. Body Diode Characteristic at  $T_J = -55^\circ\text{C}$

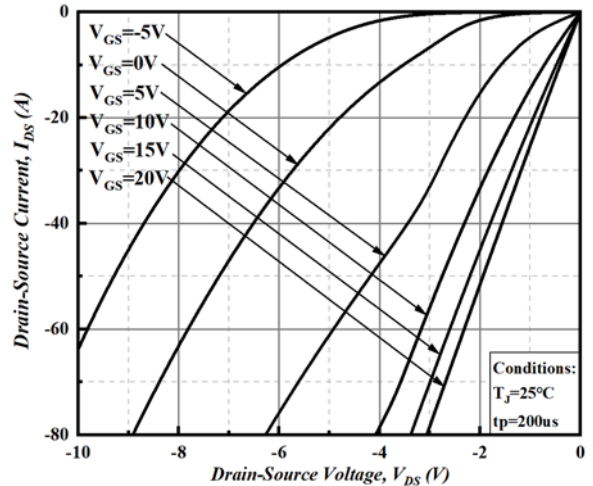

Figure 10. Body Diode Characteristic at  $T_J = 25^\circ\text{C}$

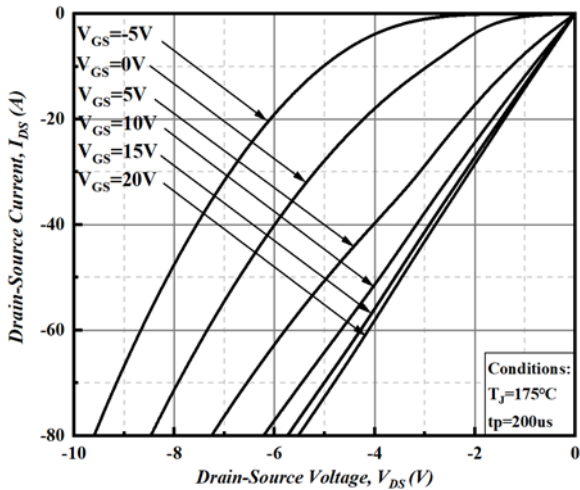

Figure 11. Body Diode Characteristic at  $T_J = 175^\circ\text{C}$

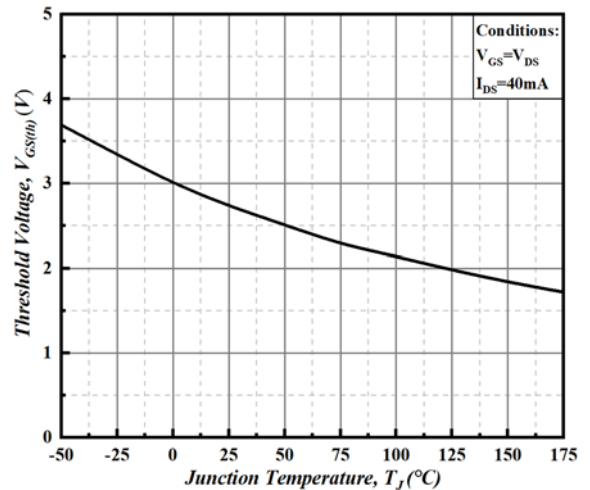

Figure 12. Threshold Voltage vs Temperature

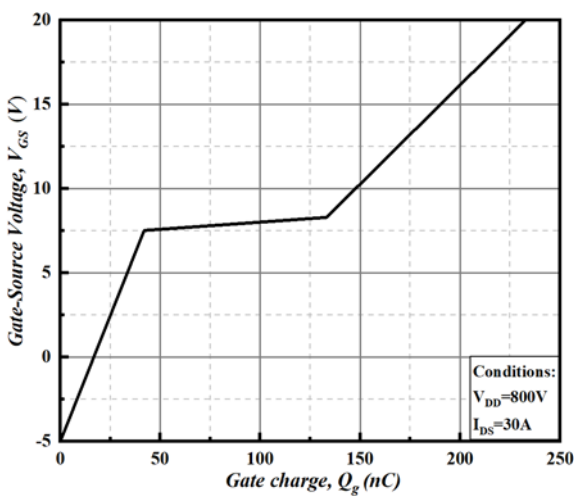

Figure 13. Gate Charge Characteristics

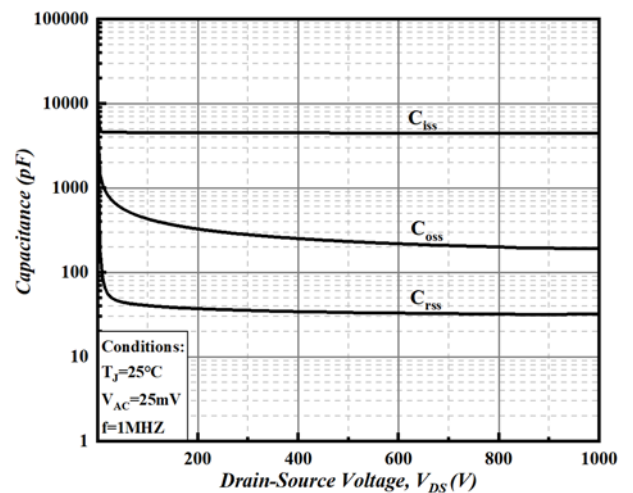

Figure 14. Capacitances vs Drain-Source Voltage (0 - 1000V)

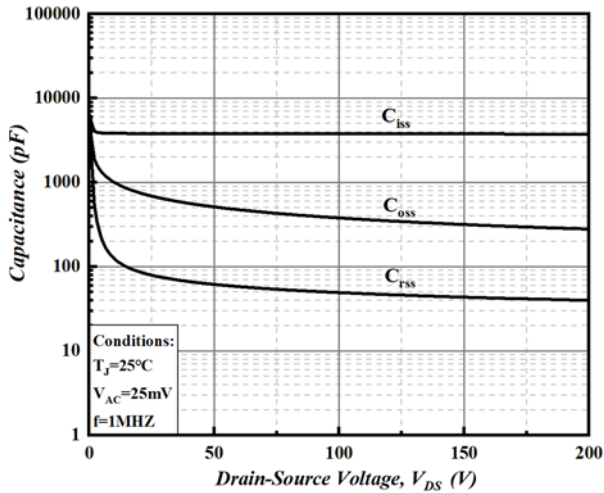

Figure 15. Capacitances vs Drain-Source Voltage (0 - 200V)

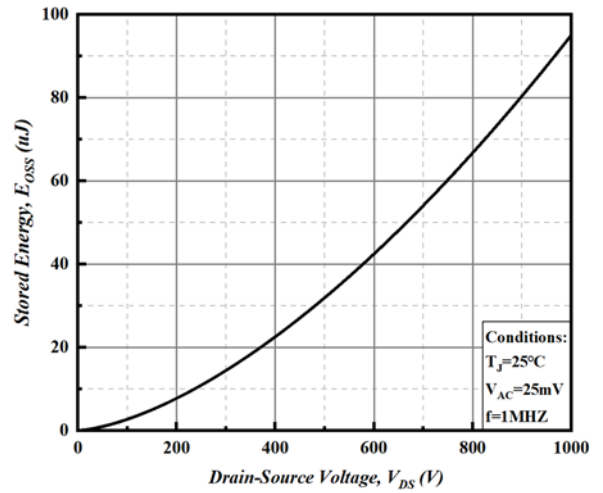

Figure 16. Output Capacitor Stored Energy

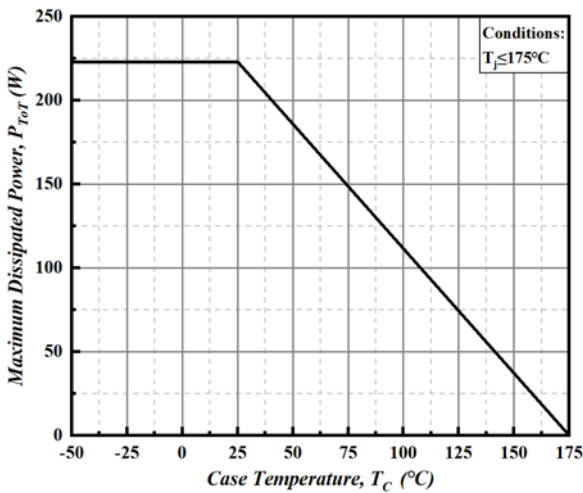

Figure 17. Maximum Power Dissipation Derating vs Case Temperature

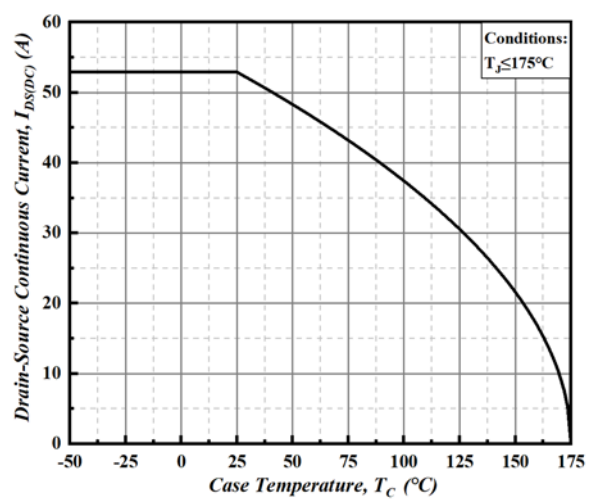

Figure 18. Continuous Drain Current vs Case Temperature

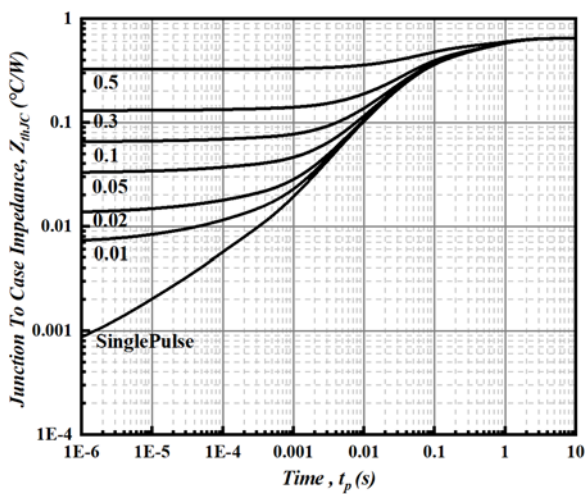

Figure 19. Transient Thermal impedance (Junction to Case)

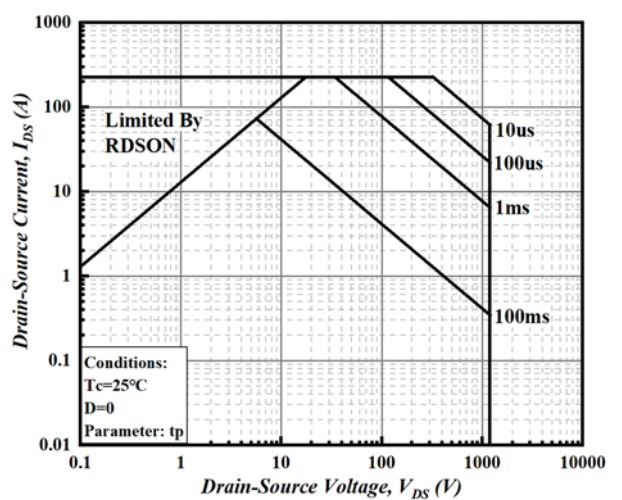
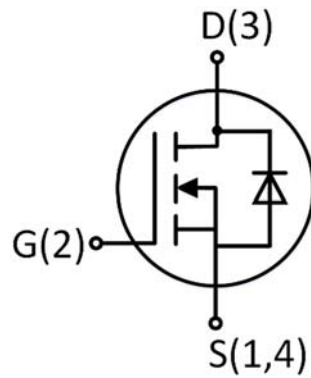

Figure 20. Safe Operating Area



● Schematic and Pin Out



● Package Dimensions (mm)

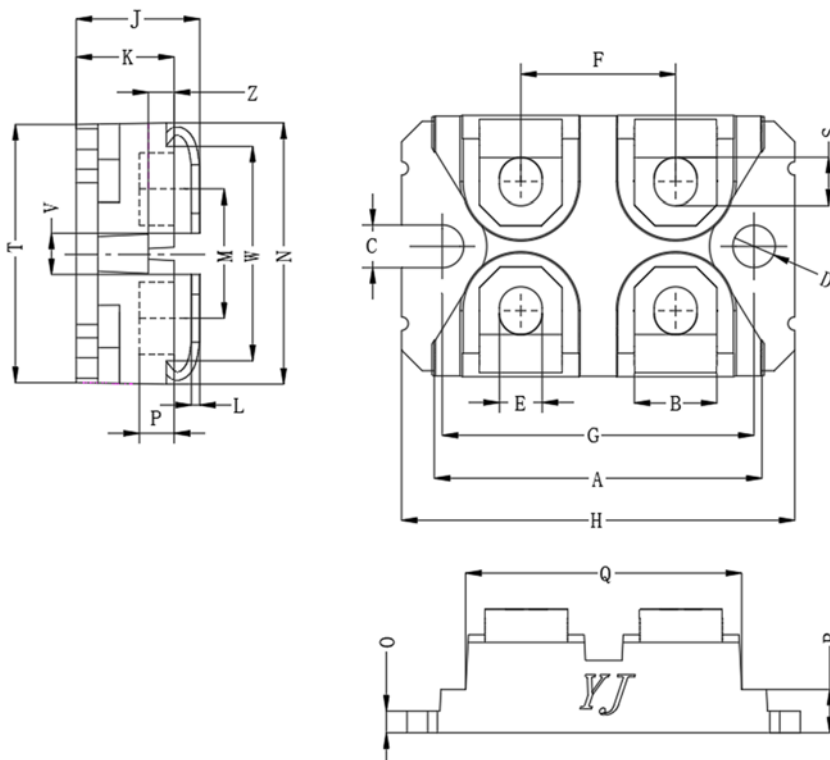

DIM	Millimeter	
	min	max
A	31.60	31.80
B	7.70	8.10
C	4.20	4.40
D	4.20	4.40
E	4.10	4.40
F	14.90	15.10
G	30.10	30.30
H	37.70	38.20
J	12.00	12.60
K	9.35	9.65
L	0.74	0.84
M	12.40	12.80
N	24.80	25.60
O	1.90	2.10
P	2.92	3.32
Q	26.60	27.00
R	3.80	4.20
S	4.95	5.45
T	23.70	24.30
V	3.50	5.50
W	20.55	20.85
Z	2.50	2.70



---

## Disclaimer

The information presented in this document is for reference only. Yangzhou Yangjie Electronic Technology Co., Ltd. reserves the right to make changes without notice for the specification of the products displayed herein to improve reliability, function or design or otherwise.

The product listed herein is designed to be used with ordinary electronic equipment or devices, and not designed to be used with equipment or devices which require high level of reliability and the malfunction of which would directly endanger human life (such as aerospace machinery, nuclear-reactor controllers, fuel controllers and other safety devices), Yangjie or anyone on its behalf, assumes no responsibility or liability for any damages resulting from such improper use of sale.

This publication supersedes & replaces all information previously supplied. For additional information, please visit our website [http:// www.21yangjie.com](http://www.21yangjie.com) , or consult your nearest Yangjie's sales office for further assistance.